

heatmiser®



neo Stat-e V2

Model: neo Stat-e V2





Table of Contents

Product Image	1	Frost Protection	20
Table of Contents	2	Power ON/OFF	21
What is a Programmable Room Thermostat?	3-4	Holiday Programming	22
Installation Procedure	5-6	Optional Features	23-26
Mode Select	7	Re-calibrating the Thermostat	27
Pairing the neoHub	8	Error Codes	27
Pairing the neoStat-e V2	8-9	Floor Temp Sensor Probe Type	28
What is a Mesh Network?	9	Diagrams	29
Approach Sensor	9	Factory Reset	30
Mode 1 - Thermostat	10	Mode 2 - Time Clock	31
LCD Display	11-12	LCD Display	32
Temperature Display	13	Setting the Switching Times	33
Setting the Clock	14	Timer Override	34
Setting the Comfort Levels	15-16	Optional Features	35
Setting the Temperature	17	Optional Features Table	35
Temperature Hold	18	Time Clock Mode Wiring Diagram	36
Locking/Unlocking the neoStat	19		

? What is a Programmable Room Thermostat?

A programmable room thermostat is both a programmer and a room thermostat.

A programmer allows you to set “On” and “Off” periods to suit your own lifestyle.

A room thermostat works by sensing the air temperature, switching on the heating when the air temperature falls below the thermostat setting, and switching it off once this set temperature has been reached.

So a programmable room thermostat lets you choose what times you want the heating to be on, and what temperature it should reach while it is on. It will allow you to select different temperatures in your home at different times of the day (and days of the week) to meet your particular needs and preferences.

Setting a programmable room thermostat to a higher temperature will not make the room heat up any faster. How quickly the room heats up depends on the design and size of the heating system.

Similarly reducing the temperature setting does not affect how quickly the room cools down. Setting a programmable room thermostat to a lower temperature will result in the room being controlled at a lower temperature, and saves energy.

The way to set and use your programmable room thermostat is to find the lowest temperature settings that you are comfortable with at the different times you have chosen, and then leave it alone to do its job.

The best way to do this is to set the room thermostat to a low temperature – say 18°C, and then turn it up by 1°C each day until you are comfortable with the temperature. You won't have to adjust the thermostat further. Any adjustment above this setting will waste energy and cost you more money.

You are able to temporarily adjust the heating program by overriding or using the temperature hold feature. These features are explained further on pages 17 and 18 of this manual.

Programmable room thermostats need a free flow of air to sense the temperature, so they must not be covered by curtains or blocked by furniture. Nearby electric fires, televisions, wall or table lamps may also prevent the thermostat from working properly.



Installation Procedure



Do

Mount the thermostat at eye level.

Read the instructions fully so you get the best from our product.



Don't

Do not install near to a direct heat source as this will affect functionality.

Do not push hard on the LCD screen as this may cause irreparable damage.

The neoStat-e V2 is designed to be flush mounted and requires a back box of 35mm (minimum depth) to be sunk into the wall prior to installation.

Step 1

Using a small screwdriver, slightly loosen the screw from the bottom face of the thermostat. Then carefully separate the front half from the back plate.

Step 2

Place the thermostat front somewhere safe.

Terminate the thermostat as shown in the diagrams on pages 29 of this booklet.

Note: For time clock wiring connections, terminate as shown on page 35.

Step 3

Screw the thermostat back plate securely into the back box.

Step 4

Clip the front of the thermostat onto the back plate, securing it in place with the retaining screw.

1



2



3

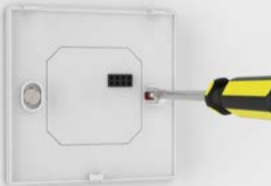

4













Mode Select

This neoStat-e V2 can either be used as a thermostat or a time clock. Thermostat mode is the default setting.

To change between thermostat or time clock modes, follow these steps.

- Use the Left / Right keys to scroll to   
- Press and hold the Tick button for 3 seconds 
- SETUP will be highlighted, now press and hold the tick key for 10 seconds..... 
- Use the Left / Right keys to scroll between modes  
 - Mode 1 = Thermostat
 - Mode 2 = Time Clock
- Press the Tick key to confirm selection 

The neoStat-e V2 will revert to the main display screen for the selected mode.

For time clock mode instructions, first pair the time clock with the neoHub as explained on page 8, then turn to page 30.



Pairing the neoHub

To pair the neoHub with the neoApp, follow these steps.





- Connect the neoHub to your router with the Ethernet cable provided.
- Connect the power supply to the neoHub.
- The router will automatically assign an IP address to the neoHub, the Link LED will light up RED once the neoHub has connected to your network.
- Once connected to the Heatmiser cloud server, the Link LED will turn GREEN.
- Connect your smartphone or tablet device to the same WiFi network as your router.
- Download the FREE Heatmiser neoApp from the Apple App Store or Google Play Store and register an account.
- Once you have registered your account, press *Sign In*, then press *Add Location*.
- Press the *connect* button on the neoHub to add the location to your account.
- When successfully connected, enter a title for the location (e.g. Home).



Pairing the neoStat-e V2

The next step is to join the neoStat-e V2 to the neoHub, we recommend joining the neoStat-e V2 located nearest to the neoHub first.

To add a neoStat-e V2, follow these steps;

- In the app, select *ADD NEOSTAT*, enter a preset or custom title, then press *NEXT*.
- You now have two minutes to join the neoStat-e V2 to the neoHub.
- On the neoStat-e V2, use the Left / Right keys to select , press and hold Tick   
- *SETUP* will be highlighted, now press the tick key once
- Feature 01 is displayed on screen.

- Press the Tick key once again to pair the neoStat to the neoHub ✓
- The MESH symbol appears flashing on the display.
- When the neoStat-e V2 successfully connects to the neoHub the MESH symbol will be permanently displayed.
- Press ADD ANOTHER for additional zones or press FINISH to complete setup.

Please note, you only have to pair the hub to your account once.

To pair any additional neoStats, select ZONES, edit, then ADD ZONE.



What is a Mesh Network

NeoStats work using a mesh network, meaning neoStats have the ability to send & receive signals via other thermostats on the network. This signal is relayed from one thermostat to another until it reaches its destination. This communication method extends the communication range whilst offering increased network stability when compared with standard RF thermostats.

The Mesh symbol is shown when the device is communicating with the neoHub, if the mesh symbol disappears this indicates connection to the neoHub has been lost.



Approach Sensor

The neoStat-e V2 uses proximity to detect when you are about to use the touch keys. As you approach the neoStat-e V2, the touch keys and backlight will light up. This can be useful if you need to adjust the set temp or timer in a dark room.

1 Mode 1 - Thermostat



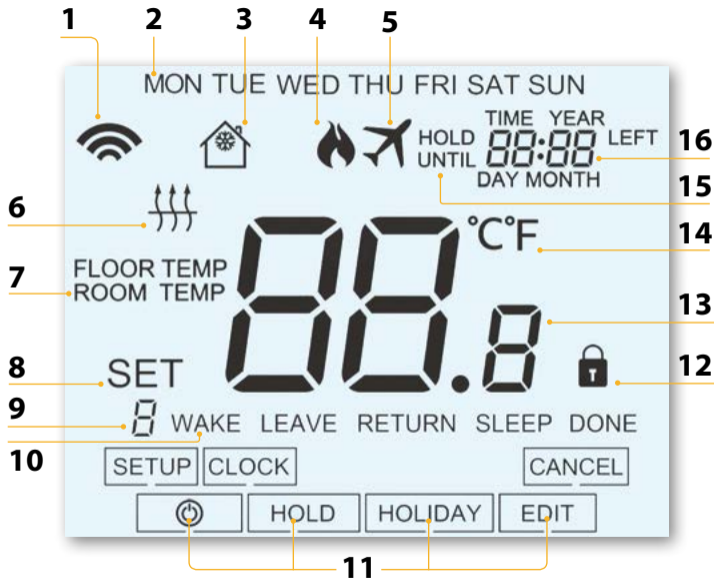

1. Mesh Symbol - Displayed when connected to the neoHub.
2. Day Indicator - Displays the day of the week.
3. Frost Protection – Displayed when frost protection is enabled.
4. Flame Symbol – Displayed when the thermostat is calling for heat and flashes when optimum start is active.
5. Holiday – Displayed when the thermostat is in holiday mode.
6. Floor Limit Symbol – Displayed when the floor probe has reached the floor temperature limit configured in the setup menu.
7. Floor/Room Temp - Indicates the displayed sensor mode.
8. Set - Displayed when changes are being made to the current set point.
9. Program Indicator - Displayed during programming (6 level mode) to show which level is being altered.
10. Program Indicator - Displayed during programming (4 level mode) to show which level is being altered.
11. Main Menu - Displays which option is currently selected.
12. Keypad Lock Indicator – Displayed when the keypad is locked.
13. Temperature – Displays the current sensor temperature.
14. Temperature Format - Degrees Celsius or Fahrenheit.
15. Hold Left - Displayed when a temperature hold is active, the remaining time will be shown.
16. Time/Day/Month/Year - Displays when setting the Clock/Calendar or a Holiday Period.



Temperature Display

The neoStat-e V2 can be configured for different sensor options such as built in air sensor, floor sensor or both. The display will clearly indicate which sensor is being used by showing either "Room Temp" or "Floor Temp" before the actual temperature value.

Room Temperature



Floor Temperature



When the neoStat-e V2 is set to use both the air & the floor sensor, the room temperature will be displayed by default.

To view the current floor temperature, press and hold the Left and Right arrow keys for 5 seconds, the floor temperature will then be displayed..... <>



Setting the Clock

To set the clock, follow these steps.

- Use the Left / Right keys to scroll to
- Press and hold Tick to turn off the display
- Use the right arrow key to select CLOCK
- Press Tick to confirm selection
- Use Up / Down keys to set the year
- Press Tick to confirm selection
- Repeat the steps to set the Month, Date & Time
- Press Tick to confirm the new clock settings
- Use the down arrow to scroll to
- Press Tick to turn the display on

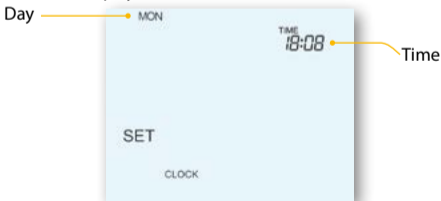
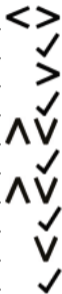



Comfort Levels Explained

The neoStat-e V2 offers three program mode options; Weekday/Weekend programming, 7 Day programming and 24 Hour programming. There is also the option to use the thermostat as a Non-Programmable thermostat.

When thermostats are connected to the mesh network, the program mode for the system is configured by using the neoApp.

The thermostat is supplied with comfort levels already programmed, but these can be changed easily. The default times and temperature settings are;

07:00 - 21°C (Wake) 09:00 - 16°C (Leave) 16:00 - 21°C (Return) 22:00 - 16°C (Sleep)

If you only want to use 2 levels, you should program the unused levels to --:--
For Weekday/Weekend programming, the four comfort levels are the same for Mon-Fri, but can be different for Sat-Sun. For 7 Day programming each day of the week can have four different comfort levels. In 24 Hour mode all days are programmed with the same comfort levels.

- To program the comfort levels, use the Left / Right keys to scroll to EDIT < >
- Press Tick to confirm selection ✓
- Use the Left / Right keys to select day / period of week (the selection will flash). < >
- Press Tick to confirm selection ✓
- WAKE will now flash and the current time and temperature setting will be shown.
- Press Tick to alter WAKE settings ✓

- Use the Up / Down keys to set the hours ^ v
- Press Tick to confirm ✓
- Use the Up / Down keys to set the minutes ^ v
- Press Tick to confirm ✓
- Use the Up / Down keys to set the temperature ^ v
- Press Tick to confirm the settings ✓
- Press the right arrow key >
- LEAVE will now flash and the current settings will be displayed.
- Press Tick to alter LEAVE settings ✓
- Repeat these steps to set all comfort levels.
- For any unused periods set time to --:--
- Use the Left / Right keys to scroll to DONE and press Tick < > ✓



Temperature Control

The Up / Down keys allow you to adjust the set temperature ^ v

When you press either key, you will see the word SET and the desired temperature value. Use the Up / Down keys to adjust the SET value ^ v

Press Tick to confirm settings and return to the main display ✓



Note: This new temperature is maintained only until the next programmed comfort level. At this time, the thermostat will revert back to the programmed levels.



Temperature Hold

The temperature hold function allows you to manually override the current operating program and set a different temperature for a desired period.

- Use the Left / Right keys to scroll to HOLD..... <>
- Press Tick to confirm selection ✓
- Use the Up / Down keys to set the desired Hold period ^ v
- Press Tick to confirm selection ✓
- Use the Up / Down keys to set the desired Hold temperature ^ v
- Press Tick to confirm selection ✓

You will see the HOLD LEFT indication is displayed on screen.

The time will countdown the set duration and then revert to the normal program.



Hold Left Indicator

Hold Time Remaining

To cancel a temperature Hold, with hold selected on the main menu, press the tick key and then press tick again while Cancel is highlighted.



Locking the neoStat-e V2

The neoStat-e V2 has a keypad lock facility. To activate the lock follow these steps.

- Use the 'Left/Right' keys to scroll to 'HOLD' & press ✓ for 10 seconds <>✓
The display will show 0000. At this point enter a four digit pin number.
- Use the Up / Down keys to enter the first two digits ^v
- Press ✓ to confirm ✓
- Use the Up / Down keys to enter the second two digits ^v
- Press ✓ to confirm ✓

The display will return to the main screen and display the keypad lock indicator 

Note: The keypad lock indicator is only displayed when the lock is active.



Unlocking the neoStat-e V2

To unlock the neoStat-e V2 press Tick once. The display will show 00:00 and you will need to enter the four digit pin number you set previously.

- Use the Up / Down and ✓ keys to enter the first two digits..... ^v✓
- Use the Up / Down and ✓ keys to enter the second two digits <>✓

The display will unlock and return to the main screen.



Frost Mode

Use the Left / Right keys to scroll to the Power Icon <> 

The frost icon will toggle ON/OFF each time Tick is pressed ✓

In this mode, the neoStat-e will display the frost icon and will only turn the heating ON should the room temperature drop below the set frost temperature (see page 23).

If the heating is turned ON whilst in frost mode, the flame symbol will be displayed.

To cancel the frost protect mode, navigate to the Power button again and press Tick. ✓



Frost Protection
Mode Enabled



Power On/Off

The heating is indicated ON when the flame icon is displayed.

When the flame icon is absent, there is no requirement for heating to achieve the set temperature but the neoStat remains active.

To turn the neoStat-e V2 off completely, scroll to the Power Icon and hold the Tick key for approximately 3 seconds until the display goes blank<> ✓

The display and heating output will be turned OFF.

To turn the thermostat back ON, press the Tick key once ✓

Thermostat completely OFF



Thermostat powered ON





Holiday

In thermostat mode, the holiday function reduces the set temperature in your home to the frost protection temperature setting (see page 23).

The thermostat will maintain this temperature for the duration of the holiday and will then automatically return to the program mode on your return.

In time clock mode, the holiday function maintains the timed output as OFF. Set a date & time for the holiday period to end, using the steps below;

- Use the Left / Right keys to scroll to HOLIDAY and press Tick <>✓
- Use the Up / Down keys to set the year ^v
- Press Tick ✓
- Use the Up / Down keys to set the month ^v
- Press Tick ✓
- Repeat the steps to set the Date & Time ^v
- Pressing Tick to confirm selection ✓

Note: The holiday period will start immediately, and will return to the normal program at the time & date you have configured.

- Use the Left / Right keys to scroll to HOLIDAY and press Tick <>
- CANCEL will be highlighted, Press Tick to cancel ✓



Optional Settings Explained

THE FOLLOWING SETTINGS ARE OPTIONAL AND IN MOST CASES NEED NOT BE ADJUSTED.

Feature 01 – Pairing To neoHub: This function is used to connect the thermostat to the neoHub.

Feature 02 - Switching Differential: This function allows you to increase the switching differential of the thermostat. The default is 1°C which means that with a set temperature of 20°C, the thermostat will switch the heating on at 19°C and off at 20°C. With a 2°C differential, the heating will switch on at 18°C and off at 20°C.

Feature 03 - Frost Protect Temperature: This is the temperature maintained when the thermostat is in Frost Mode. The range is 07 - 17°C. The default is 12°C and is suitable for most applications.

Feature 04 – Output Delay: To prevent rapid switching, an output delay can be entered. This can be set from 00 - 15 minutes. The default is 00 which means there is no delay.

Feature 05 – Temperature Up/Down Limit: This function allows you to limit the use of the up and down temperature arrow keys. This limit is also applicable when the thermostat is locked and so allows you to give others limited control over the heating system.

Feature 06 – Sensor Selection: On this neoStat, you can select which sensor should be used. You can select between air temperature only, floor temperature, or both. When you enable both sensors, the floor sensor is used as a floor limiting sensor and is designed to prevent the floor from overheating.

Feature 07 – Floor Temp Limit: This function is available when mode 06 is set to 03 or 04. You can set a floor limiting temperature between 20–45°C (28°C is the default setting).

Note: Air Sensor only MUST NOT be used to control electric under-floor heating. Floor Sensor or Both should be used.

Feature 08 – Optimum Start: Optimum start will delay the start up of the heating system to the latest possible moment to avoid unnecessary heating and ensure the building is warm at the programmed time. The thermostat uses the rate of change information to calculate how long the heating needs to raise the building temperature 1°C (with a rate of change of 20, the thermostat has calculated the heating needs 20 minutes to raise the building temperature 1°C) and starts the heating accordingly.

Feature 09 – Rate of Change: Number of minutes for 1°C temperature rise.

Feature 10 – Not used on this model.

Feature 11 – Not used on this model.

Feature 12 – Program Mode: Non-Programmable, Weekday/Weekend (5/2), 7 Day Programming or 24 Hour. The thermostat offers three programming modes and the option of configuring it to work as a non-programmable thermostat.

Weekday/Weekend - allows you to program 4 comfort levels for the weekday and 4 different comfort levels for the weekend.

7 Day Program Mode - Each day has 4 comfort levels that can be programmed independently.

24 Hour Mode - All days are programmed the same and repeat continuously.

Feature 13 - Temperature Format: This function allows you to select between °C and °F.



Adjusting the Optional Settings

- Use the Left / Right keys to scroll to 
- Press and hold the Tick button for 3 seconds
- SETUP will be highlighted, now press the tick key once

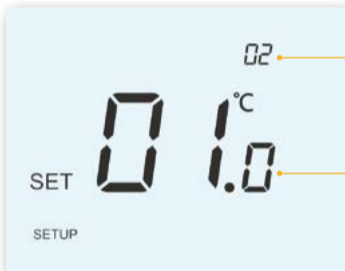

- Use the Up / Down keys to scroll through features
- Use the Left / Right keys to adjust the setting within each feature
- Press Tick to confirm and exit setup menu













Optional Settings - Feature Table

FEATURE	DESCRIPTION	SETTING
01	Pairing	Used to add zone to the neoHub
02	Switching Differential	00.5 = 0.5°C 01 = 1.0°C (Default) 02 = 2.0°C 03 = 3.0°C
03	Frost Protection Temperature	07° - 17°C (12°C = Default)
04	Output Delay	00 - 15 Minutes (00 = Default)
05	Up/Down Temperature Limit	00° - 10°C (00 = Default)
06	Sensor Selection	00 = Built in Sensor (Default) 01 = Remote Air Sensor 02 = Floor Sensor Only 03 = Built in & Floor Sensor 04 = Remote Air & Floor Sensor
07	Floor Temperature Limit	20°C - 45°C (28°C = Default)
08	Optimum Start	00 - 05 Hours (00 = Default)
09	Rate of Change	Minutes to raise by 1°C
10	Not used on this model	
11	Not used on this model	
12	Program Mode	00 = Non - Programmable 01 = Weekday/Weekend (Default) 02 = 7 Day Programming 03 = 24 Hour Mode
13	Temperature Format	00 = °C, 01 = °F (00 = Default)



Re-calibrating the Thermostat

If you need to re-calibrate the thermostat, follow these steps.

- Use the Left / Right keys to scroll to    
- Press and hold Tick to turn the display OFF ✓
- Press and hold the Tick and Down keys together for 10 seconds ✓ 
- The current temperature will appear on the display.
- Use the Up / Down keys to configure the new temperature value  
- Press the Tick key to confirm the change and the display will go blank ✓
- Press the down arrow to highlight the  
- Press the Tick key once to turn the thermostat ON ✓



Error Codes

When terminated for thermostat operation the screen will display an error code if a fault is detected.









- E0 = The internal sensor has developed a fault.
- E1 = The remote FLOOR probe has not been connected.
The remote FLOOR probe has not been wired correctly.
The remote FLOOR probe is faulty.
- E2 = The remote AIR probe has not been connected.
The remote AIR probe has not been wired correctly.
The remote AIR probe is faulty.



Floor Temperature Sensor Probe Type

The neoStat-e is supplied with a 10K floor sensor probe & is compatible with two other common probe values which are 12K or 15K.

To change the neoStat-e to use a different probe type, follow these steps;

- Use the Left / Right keys to scroll to   
- Press and hold Tick to turn the display OFF 
- Press and hold the Up and Down keys together for 5 seconds  
- Use the Left / Right keys to scroll between the different probe values  



10 = 10K Probe



12 = 12K Probe



15 = 15K Probe

- Press the Tick key to confirm selection 

The neoStat-e will revert to the main display configured for the new probe type.

Note: This change should only be carried out by an experienced technician who has accurately verified the probe value being used.



Wiring Diagram - neoStat-e

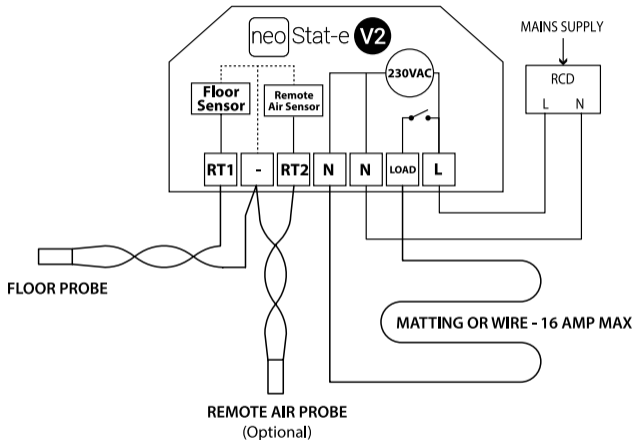











This product must only be installed by a qualified electrician and comply with local installation regulations.



Factory Reset

To reset the device to factory default settings, follow these steps:

- Use the Left / Right keys to scroll to   
- Press and hold Tick to turn the display OFF 
- SETUP will be highlighted  
- Press and hold the Tick key for 10 seconds 
- All of the icons on the display will appear for 2 seconds, then you will see the number 1 or 2 flashing.
- Use the Left / Right keys to scroll between modes (selection will flash)  
 - Mode 1 = Thermostat
 - Mode 2 = Time Clock
- Press the Tick key to confirm selection 

The neoStat will revert to the main display screen for the selected mode.

Note: Factory reset will cancel all parameters that were entered during the set-up and pairing operations. These processes must be repeated after factory reset is completed.

1. Mesh Symbol - Displayed when connected to the neoHub.
2. Day Indicator - Displays the day of the week.
3. Holiday – Displayed when the time clock is in holiday mode.
4. Set - Displayed when changes are being made to the current set point.
5. Program Indicator - Displayed during programming to show which level is being altered.
6. Main Menu - Displays which option is currently selected.
7. Keypad Lock Indicator – Displayed when the keypad is locked.
8. Timer Status – Displays the current state of the timed output.
9. Hold Left - Displayed when a timer hold is active, the remaining time will be shown.
10. Time/Day/Month/Year - Displays when setting the Clock/Calendar or a Holiday Period.



Setting the Switching Times

To program the switching times, follow these steps.

- Use the Left / Right keys to scroll to EDIT and press Tick
- Use the Left / Right keys to select day/period of the week
- Press Tick to confirm selection
- 1 will now flash and the current ON time will be displayed.
 The OFF time can be viewed by pressing the Down key
- Select a switching time and press the Tick key
- Use the Up / Down keys to select the ON time HOURS and press Tick
- Use the Up / Down keys to select the ON time MINUTES
- Press Tick to confirm selection
- Use the Up / Down keys to select the OFF time HOURS and press Tick
- Use the Up / Down keys to select the OFF time MINUTES
- Press Tick to confirm selection
- Press the Right arrow key
- 2 will now flash and the current ON time will be displayed.
- Repeat the steps above to set all periods. For any unused periods enter -- :-
- When complete, use the Left / Right keys to scroll to DONE and press Tick to confirm all changes





Timer Override

To override the timed output on, follow these steps.

- Use the Up / Down keys to set the override duration e.g. 02:00 hours
- Press Tick to confirm settings and return to main display



Hold Left and the remaining time will now be displayed.



HOLD LEFT Indicator

Hold Time Remaining



Optional Features Explained

Feature 01 – Pairing To neoHub: This function is used to connect the time clock to the neoHub.

Feature 02 - Weekday/Weekend (5/2), 7 Day Programming or 24 Hour Mode:

The time clock offers three programming methods;

Weekday/ Weekend (5/2) - Allows you to program 4 on/off switching times for the weekdays and 4 on/off switching times for the weekend.

7 Day Program Mode - Each day has 4 on/off switching times that can be programmed independently.

24 Hour Mode - All days are programmed with the same on/off switching times.



Optional Settings - Feature Table

FEATURE	DESCRIPTION	SETTING
01	Pairing	Used to pair to the neoHub
02	Program Mode	01 = Weekday/Weekend Programming (Default) 02 = 7 Day Programming 03 = 24 Hour Mode



Wiring Diagram - Time Clock Mode

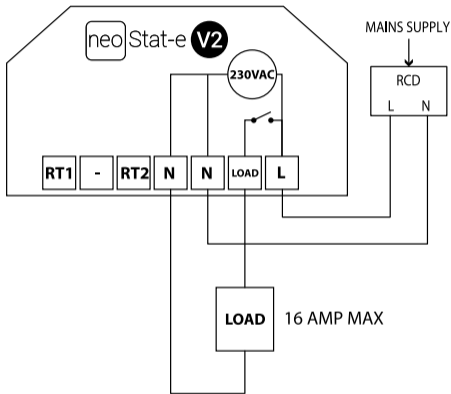

This product must only be installed by a qualified electrician and comply with local installation regulations.



Notes

A series of horizontal dotted lines for writing notes, spanning the width of the page.



Notes

A series of horizontal dotted lines for writing notes, spanning the width of the page.



Want More Information?

Call our support team on: +44 (0)1254 669090

Or view technical specifications directly on our website:
www.heatmiser.com



PDF



FAQ

Heatmiser UK Ltd

Units 1-5 Hurstwood Court, Mercer Way
Shadsworth Business Park, Blackburn,
Lancashire, BB1 2QU, United Kingdom.



Twitter: @heatmiseruk



Facebook: facebook.com/thermostats