



Driver LC 35W 24V bDW SC PRE2

premium series constant voltage

Product description

- Dimmable 24 V constant voltage LED Driver for flexible constant voltage strips
- basicDIM Wireless enables different dimming options
- Forms automatically a wireless communication network with up to 127 nodes
- Dimming range 1 to 100 %
- No additional external dimmer is needed
- Suitable for emergency escape lighting systems acc. to EN 50172
- Nominal life-time up to 50,000 h
- 5-year guarantee

Typical application

- Cove lighting, facade accent lighting, ceiling integration

Technical details

- 24 V, 35 W
- Small design (195 x 43 x 30.2 mm) with stretched-compact strain relief
- Small cross section
- Push terminal for simple wiring
- 1 output channel (+/-)

Interfaces

- basicDIM Wireless
- ready2mains (configuration via mains)
- Terminal blocks: 45° push terminals

System solution

- Tridonic LLE-FLEX ADV 600, 1,200, 1,800 lm/m
- Tridonic LLE-FLEX EXC 600, 1,200, 1,800, 2,500 lm/m
- In connection with Flex accessories wire to PCB plug



System solution



Standards, page 3

IP20 SELV      RoHS

Driver LC 35W 24V bDW SC PRE2

premium series constant voltage

Technical data

Rated supply voltage	220 – 240 V
AC voltage range	198 – 264 V
DC voltage range	176 – 280 V
Mains frequency	0 / 50 / 60 Hz
Typ. current (at 230 V, 50 Hz, full load) ^①	176 mA
Typ. current (220 V, 0 Hz, full load, 15 % dimming level)	37 mA
Leakage current (at 230 V, 50 Hz, full load) ^①	< 320 µA
Max. input power	40 W
Typ. efficiency (at 230 V / 50 Hz / full load)	89 %
λ (at 230 V, 50 Hz, full load) ^①	0.98
Typ. power input on stand-by	< 0.35 W
Typ. input current in no-load operation	26.5 mA
Typ. input power in no-load operation	1.78 W
In-rush current (peak / duration)	21.6 A / 136 µs
THD (at 230 V, 50 Hz, full load) ^①	< 6.7 %
Starting time (at 230 V, 50 Hz, full load) ^①	< 0.6 s
Starting time (DC mode)	< 0.3 s
Switchover time (AC/DC)	< 0.3 s
Turn off time (at 230 V, 50 Hz, full load)	< 3 ms
Output voltage tolerance	± 1 V
Output LF voltage ripple (< 120 Hz)	± 5 %
Max. output voltage (no-load voltage)	60 V
PWM frequency	~ 1 kHz
Dimming range	1 – 100 %
Mains surge capability (between L – N)	1 kV
Mains surge capability (between L/N – PE)	2 kV
Dimensions L x W x H	195 x 43 x 30.2 mm

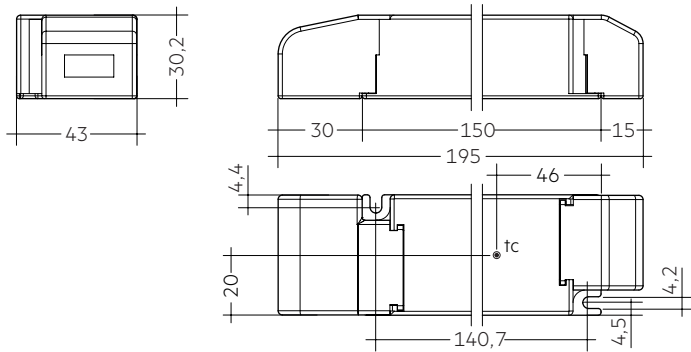

Ordering data

Type	Article number	Packaging carton [®]	Packaging pallet	Weight per pc.
Multi packaging				
LC 35/24V bDW SC PRE2	28002415	10 pc(s).	390 pc(s).	0.15 kg
Single packaging				
LC 35/24V bDW SC PRE2 SP	28002677	10 pc(s).	480 pc(s).	0.15 kg

[®] The strain relief is included in both packaging variants.
In the single packaging each Driver has also an individual packaging.

Specific technical data

Type	Load	Forward voltage	Output current	Max. output power (at 24 V, full load)	Typ. power consumption (at 24 V, full load)	Typ. current consumption (at 24 V, full load)	Max. casing temperature tc	Ambient temperature ta max.
LC 35/24V bDW SC PRE2	10 %	24 V	0.146 A	3.5 W	5.9 W	41 mA	75 °C	-25 ... +60 °C
	20 %	24 V	0.292 A	7.0 W	9.6 W	57 mA	75 °C	-25 ... +60 °C
	30 %	24 V	0.437 A	10.5 W	13.4 W	71 mA	75 °C	-25 ... +60 °C
	40 %	24 V	0.583 A	14.0 W	17.0 W	85 mA	75 °C	-25 ... +60 °C
	50 %	24 V	0.729 A	17.5 W	20.7 W	99 mA	80 °C	-25 ... +60 °C
	60 %	24 V	0.875 A	21.0 W	24.5 W	114 mA	80 °C	-25 ... +60 °C
	70 %	24 V	1.021 A	24.5 W	28.3 W	130 mA	80 °C	-25 ... +60 °C
	80 %	24 V	1.167 A	28.0 W	32.0 W	145 mA	75 °C	-25 ... +50 °C
	90 %	24 V	1.313 A	31.5 W	35.7 W	161 mA	75 °C	-25 ... +50 °C
	100 %	24 V	1.453 A	35.0 W	39.4 W	176 mA	75 °C	-25 ... +50 °C

^① Valid at 100 % dimming level.

1. Standards

EN 55015
EN 61000-3-2
EN 61000-3-3
EN 61347-1
EN 61347-2-13
EN 62384
EN 61547
EN 300330 V2.11
EN 301489-1 V2.11
EN 301489-3 V2.11
EN 300328 V2.11
EN 301489-17 V2.11

According to EN 50172 for use in central battery systems

According to EN 60598-2-22 suitable for emergency lighting installations

1.1 Glow wire test

according to EN 61347-1 with increased temperature of 850 °C passed.

2. Thermal details and life-time

2.1 Expected life-time

Expected lifetime						
Type	Output load	ta	30 °C	40 °C	50 °C	60 °C
	35 – 26 W	tc	60 °C	65 °C	75 °C	–
		Life-time	> 100,000 h	> 100,000 h	55,000 h	–
LC 35/24V bDW SC PRE2	25 – 16 W	tc	–	60 °C	70 °C	80 °C
		Life-time	–	> 100,000 h	95,000 h	55,000 h
	≤ 15 W	tc	–	60 °C	65 °C	75 °C
		Life-time	–	> 100,000 h	> 100,000 h	65,000 h

The LED control gear is designed for a life-time stated above under reference conditions and with a failure probability of less than 10 %.

The relation of tc to ta temperature depends also on the luminaire design.

If the measured tc temperature is approx. 5 K below tc max., ta temperature should be checked and eventually critical components (e.g. ELCAP) measured. Detailed information on request.

3. Installation / wiring

3.1 Circuit diagram

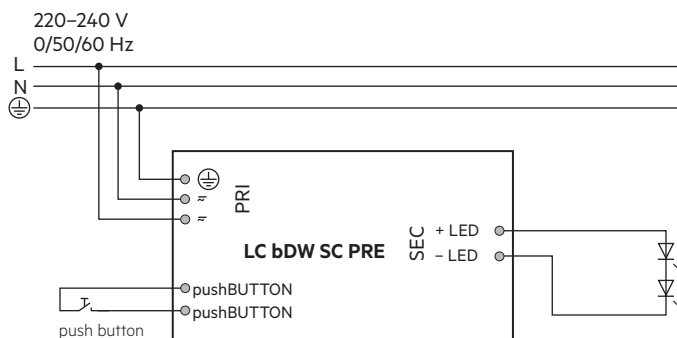

The used push button has to be isolated.

3.2 Wiring type and cross section

The wiring can be in stranded wires with ferrules or solid with a cross section of 0.2–1.5 mm². Strip 8.5–9.5 mm of insulation from the cables to ensure perfect operation of the push-wire terminals.

Use one wire for each terminal connector only.
Use each strain relief channel for one cable only.

LED module/LED Driver/supply

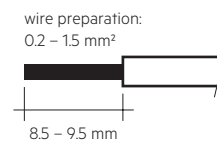

Secondary strain relief for cables with bigger cable sheath

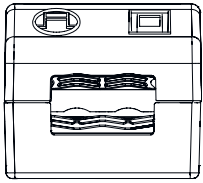

Secondary strain relief for cable with smaller cable sheath

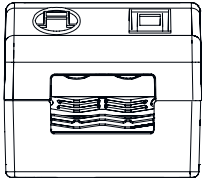

3.3 Loose wiring

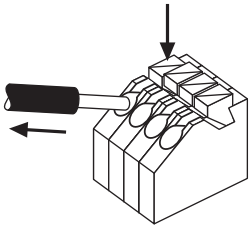

Release of the wiring

Press down the “push button” and remove the cable from front.

3.4 Fixing conditions when using as independent Driver with Clip-On

Dry, acidfree, oilfree, fatfree. It is not allowed to exceed the maximum ambient temperature (t_a) stated on the device. Minimum distances stated below are recommendations and depend on the actual luminaire. Device is not suitable for fixing in corner.

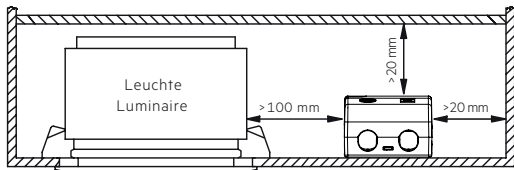

3.5 Wiring guidelines

- The cables should be run separately from the mains connections and mains cables to ensure good EMC conditions.
- The LED wiring should be kept as short as possible to ensure good EMC. The max. secondary cable length is 2 m (4 m circuit), this applies for LED output as well as for pushBUTTON.
- The secondary wires (LED module) should be routed in parallel to ensure good EMC performance.
- Secondary switching is not permitted.
- The LED Driver has no inverse-polarity protection on the secondary side. Wrong polarity can damage LED modules with no inverse-polarity protection.
- Wrong wiring of the LED Driver can lead to malfunction or irreparable damage.
- To avoid the damage of the Driver, the wiring must be protected against short circuits to earth (sharp edged metal parts, metal cable clips, louver, etc.).

3.6 Hot plug-in

Hot plug-in is not supported due to residual output voltage of > 0 V. If a LED load is connected the device has to be restarted before the output will be activated again. This can be done via mains reset or interface (basicDIM Wireless).

3.7 Earth connection

The earth connection is conducted as protection earth (PE). The LED Driver can be earthed via earth terminal. If the LED Driver will be earthed, protection earth (PE) has to be used. There is no earth connection required for the functionality of the LED Driver. Earth connection is recommended to improve following behaviour:

- Electromagnetic interferences (EMI)
- LED glowing at standby
- Transmission of mains transients to the LED output

In general it is recommended to earth the LED Driver if the LED module is mounted on earthed luminaire parts respectively heat sinks and thereby representing a high capacity against earth.

4. Electrical values

4.1 Efficiency vs. load

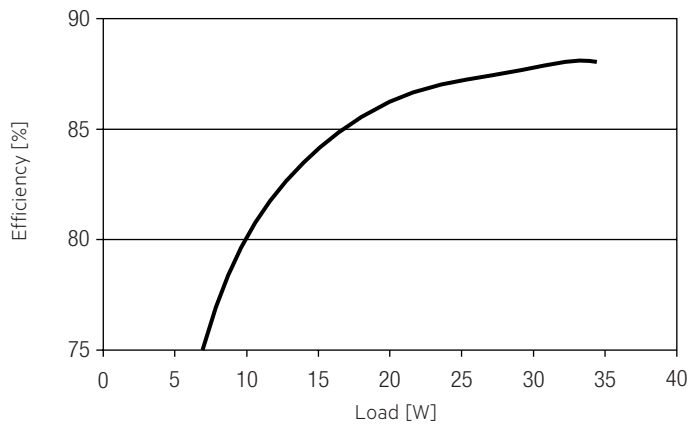

4.4 Input current vs. Load

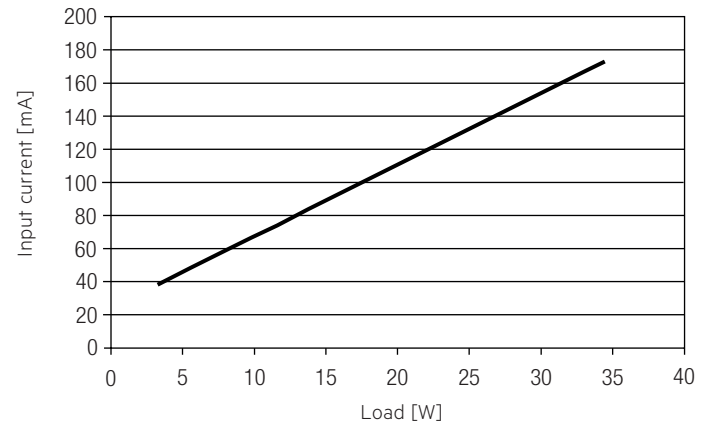

4.2 Power factor vs. Load

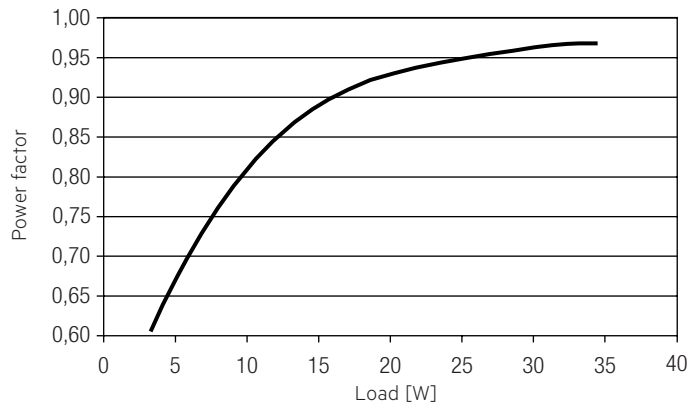

4.5 THD vs. Load

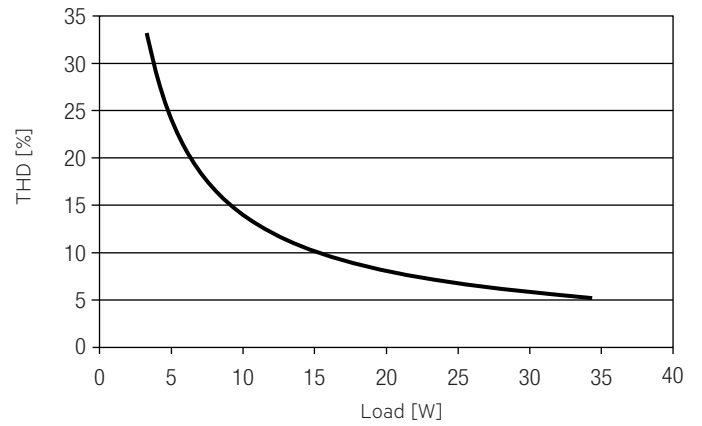

4.3 Input power vs. Load

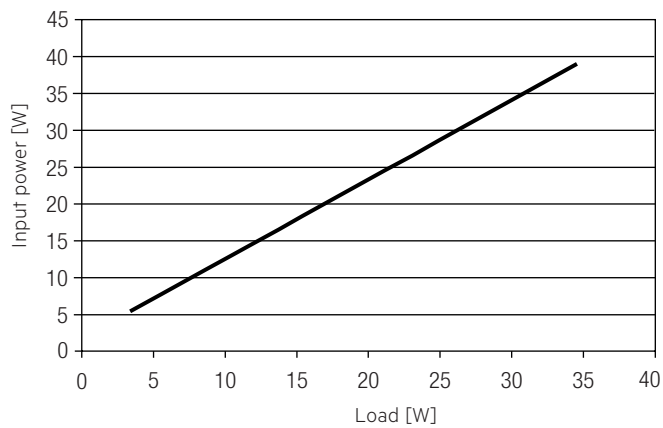

4.6 Maximum loading of automatic circuit breakers

Automatic circuit breaker type	C10	C13	C16	C20	B10	B13	B16	B20	Inrush current	
Installation Ø	1.5 mm ²	1.5 mm ²	2.5 mm ²	4 mm ²	1.5 mm ²	1.5 mm ²	2.5 mm ²	4 mm ²	I_{max}	time
LC 35/24V bDW SC PRE2	27	37	47	60	16	22	28	36	21.6 A	136 µs

Typical values for MCB from ABB series S200 as reference.
Actual values can differ due to used MCB types and installation environment.

4.7 Harmonic distortion in the mains supply (at 230 V / 50 Hz and full load) in %

	THD	3.	5.	7.	9.	11.
LC 35/24V bDW SC PRE2	6	6	1	2	2	1

4.8 Dimming

Dimming range 1% to 100 %
Digital control with:
• basicDIM Wireless

4.9 Dimming characteristics

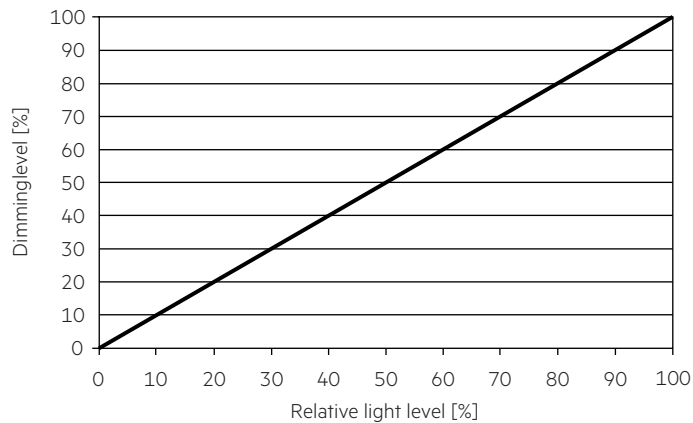

5. Interfaces / communication

5.1 Control input

A standard push button can be connected on the input terminals.
Maximum cable length of the push button is 1 meter.
This function have to be activated before using.

The control signal is not SELV. Control cable has to be installed in accordance to the requirements of low voltage installations.
Different functions depending on each module.
Profile change see handbook https://www.tridonic.com/com/en/download/technical/Documentation_Triconic_4remote_BT_EN.pdf

5.2 Control input ready2mains (L, N)

The digital ready2mains protocol is modulated onto the mains signal which is wired to the mains terminal (L and N).

6. Functions

6.1 ready2mains – configuration

The ready2mains interface can be used to configure the main parameters of LED Drivers via the mains wiring, such as LED output current, CLO and DC level. These parameters can be adjusted either via ready2mains-capable configuration software or directly via the ready2mains programmer (output current only).

6.2 Short-circuit behaviour

In case of a short-circuit at the LED output the LED output is switched off. After restart of the LED Driver the output will be activated again. The restart can either be done via mains reset or via Software or pushBUTTON.

6.3 Overload protection

If the output voltage range is exceeded the LED Driver turns off the LED output. After restart of the LED Driver the output will be activated again. The restart can either be done via mains reset or via Software or pushBUTTON.

6.4 Overtemperature protection

The LED Driver is protected against temporary thermal overheating. If the temperature limit is exceeded the output current of the LED module(s) is reduced. The temperature protection is activated approx. +5 °C above $t_{c\ max}$ (see page 2). On DC operation this function is deactivated to fulfill emergency requirements.

6.5 Constant light output (CLO)

The luminous flux of a LED decreases constantly over the life-time. The CLO function ensures that the emitted luminous flux remains stable. For that purpose the LED current will increase continuously over the LED life-time.
Via ready2mains and by software (utilityAPP) it is possible to select a start value (in percent) and an expected life-time.
The LED Driver adjusts the current afterwards automatically.

6.6 Power-up/-down fading

The power-up/-down function offers the opportunity to modify the on-/off behavior. The time for fading on or off can be adjusted in a range of 0.2 to 16 seconds. According to this value, the device dims either from 0 % up to the power-on level or from the current set dim level down to 0 %.
This feature applies while operating via 4remoteBT and when switching the mains voltage on or off. By factory default no fading time is set (= 0 seconds).

6.7 Light level in DC operation

The LED Driver is designed for operation on DC voltage and pulsed DC voltage.

Light output level in DC operation: programmable 1 – 100 % (EOFu = 0.13).
Programming by ready2mains.
In DC operation dimming mode can be activated.

The voltage-dependent input current of Driver incl. LED module is depending on the used load.

6.8 Software / programming

With appropriate software and an interface different functions can be activated and various parameters can be configured in the LED Driver. To do so, a ready2mains programmer or utilityAPP is required.

7. Miscellaneous

7.1 Isolation and electric strength testing of luminaires

Electronic devices can be damaged by high voltage. This has to be considered during the routine testing of the luminaires in production.

According to IEC 60598-1 Annex Q (informative only!) or ENEC 303-Annex A, each luminaire should be submitted to an isolation test with 500 V_{DC} for 1 second. This test voltage should be connected between the interconnected phase and neutral terminals and the earth terminal.
The isolation resistance must be at least 2 MΩ.

As an alternative, IEC 60598-1 Annex Q describes a test of the electrical strength with 1500 V_{AC} (or 1.414 x 1500 V_{DC}). To avoid damage to the electronic devices this test must not be conducted.

7.2 Conditions of use and storage

Humidity: 5 % up to max. 85 %,
not condensed
(max. 56 days/year at 85 %)

Storage temperature: -40 °C up to max. +80 °C

The devices have to be acclimatised to the specified temperature range (ta) before they can be operated.

7.3 Placement

basicDIM Wireless has an integrated antenna for easy integration. In order to maximize the range in every direction some design guidelines should be taken into consideration when mounting the device.

The antenna is located on the corner of the enclosure. It is on the top side of the internal PCB (Printed Circuit Board).

When the device is mounted on a metal plate (e.g. frame of a luminaire), it may efficiently block the radio frequency signal. In this case, a cut-out underneath the antenna may be needed for the RF signal to exit the structure. The cut-out area should be as large as possible. Also the device should be placed as far away from any vertical metal structures as possible.

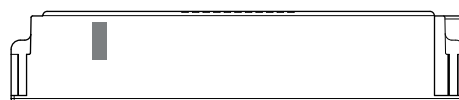

■ Antenna location

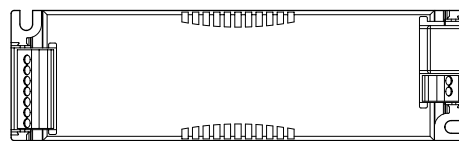

The range of the communication signal is depending on the environment e.g. luminaire, construction of the building, furnitures or humans and needs to be tested and approved in the installation.

7.4 Maximum number of switching cycles

All LED Driver are tested with 50,000 switching cycles.
The actually achieved number of switching cycles is significantly higher.

7.5 Additional information

Additional technical information at www.tridonic.com → Technical Data

Guarantee conditions at www.tridonic.com → Services

Life-time declarations are informative and represent no warranty claim.
No warranty if device was opened.