

## 2.4G Wireless Grouping Controller LC-0RGB-D4-20



### Description:

The controller adopt high performance processor, and control single color LED strip, white strip and warm white strip, RGB strip via 3 touch sliding ring remote controllers of 2.4G. User can choose color, mode and change speed via 2.4G touch sliding ring wireless grouping remote controller; exquisite dimming, no flicker. A remote controller can control multiple sets of controller, and single set controller has synchronous function, can realized synchronous effect.

### Features:

1. Max. control distance of controller can be up to 100m (in open condition);
2. Automatic remember current change state;
3. Each remote controller can control multiple controllers.

### Technical parameters:

1. Working voltage: 12/24V DC;	9. Working environment: indoor
2. Max. current: 3A*3CH Max. 9A;	10. Waterproof grade: IP20;
3. Max. power: 108W(12V)/216W(24V);	11. Working temperature range: -30 °C-55°C;
4. Wireless transmission frequency : 2.4GHz;	12. Inner box dimension: L210*W140*H24mm;
5. Receiving sensitivity : -96dBm;	13. Outer carton dimension: 407*304.5*298mm;
6. Transmitting power: 6dBm;	14. Weight of single piece (gross weight): about 50g;
7. Control distance: 100m (in open condition);	15. Weight of whole carton: about 8kg;
8. Change mode: 52 colors (RGB);	16. Qty. Of whole carton: 48 pieces/carton

## Function description of remote controller:

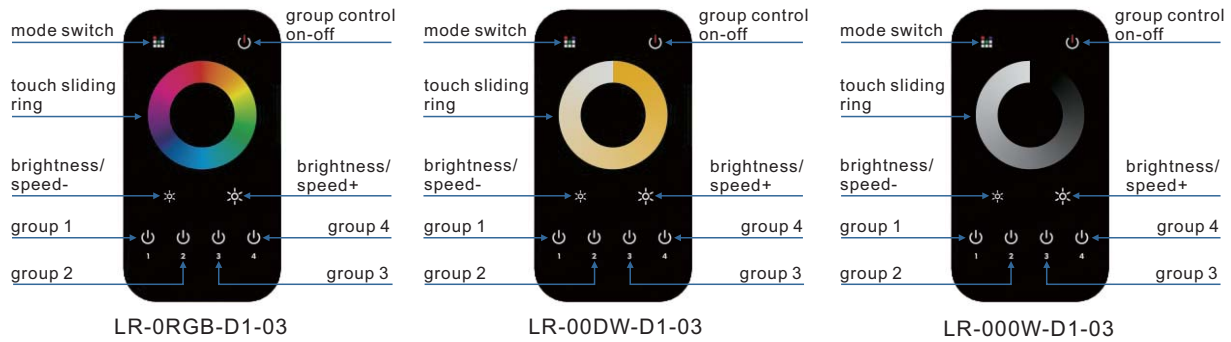

### 1.Key description of remote controller







### 2. Matching steps of remote controller

After power on controller, short press , press any key of sliding ring on remote controller, then match success.

### 3.Grouping control steps of remote controller

(1) Power on the first controller, short press , and touch  on remote controller, then remote controller and the first controller are matched the first group; if you want to add more controllers in the group, just repeat above operation.

(2) Get the second controller, power on, short press , touch  on remote controller, then the remote controller and the second controller are matched the second group; if you want to add more controllers in the group, just repeat above operation.

(3) There are 4 groups of controller, if you want to control the first group, only touch , then you can perform dimming operation on the first group; if you want to control the second group, only touch , then you can perform dimming operation on the second group; if you want to control group 1, group 2, group 3, group 4 together, touch , then you can perform dimming operation on all controllers of the 4 groups.

### Dimension (unit:mm)

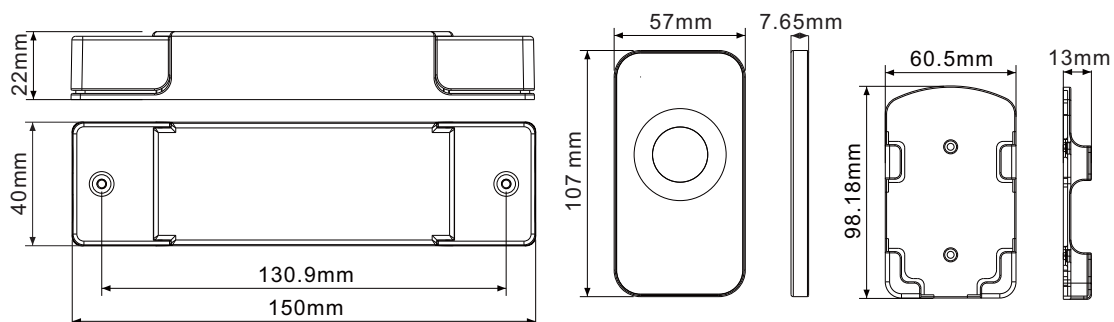

## Color modes:

### ● 2.4G wireless touch sliding ring remote controller(LR-ORGB-D1-03)

1. static red
2. static green
3. static blue
4. static yellow
5. static purple
6. static cyan
7. static white
8. red-green jump change
9. red-blue jump change
10. green-blue jump change
11. yellow-cyan jump change
12. yellow-purple jump change
13. cyan-purple jump change
14. red-green-blue jump change
15. yellow-purple-cyan jump change
16. red- green -blue -yellow -purple - cyan- white -jump change
17. red gradual change
18. green gradual change
19. blue gradual change
20. yellow gradual change
21. purple gradual change
22. cyan gradual change
23. white gradual change
24. red-green gradual change
25. red-blue gradual change
26. green-blue gradual change



27. yellow-cyan gradual change
28. yellow-purple gradual change
29. cyan-purple gradual change
30. red-green-blue gradual change
31. yellow-purple-cyan gradual change
32. red-green-blue-yellow-purple-cyan-white gradual change
33. red-green mixed color gradual change
34. red-blue mixed color gradual change
35. green-blue mixed color gradual change
36. red-green-blue mixed color gradual change
37. red flicker change
38. green flicker change
39. blue flicker change
40. yellow flicker change
41. purple flicker change
42. cyan flicker change
43. white flicker change
44. red green flicker change
45. red blue flicker change
46. green blue flicker change
47. yellow cyan flicker change
48. yellow purple flicker change
49. cyan purple flicker change
50. red-green-blue flicker change
51. yellow-purple-cyan flicker change
52. red-green-blue-yellow-purple-cyan-white flicker change

### ● 2.4G white/warm white wireless touch sliding ring remote controller (LR-00DW-D1-03)

1. Static white
2. Static warm white
3. Static white/warm white
4. 3 colors jump change;
5. White flicker;
6. Warm white flicker:
7. White/warm white flicker
8. 3 colors flicker
9. White gradual change
10. Warm white gradual change
11. White/warm white gradual change
12. 3 colors jump change
13. white/warm white alternating gradual change

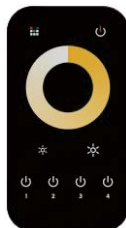

### ● 2.4G single color touch sliding ring wireless remote controller(LR-000W-D1-03)

1. Static white
2. White gradual change
3. White jump change



## Wiring diagram:

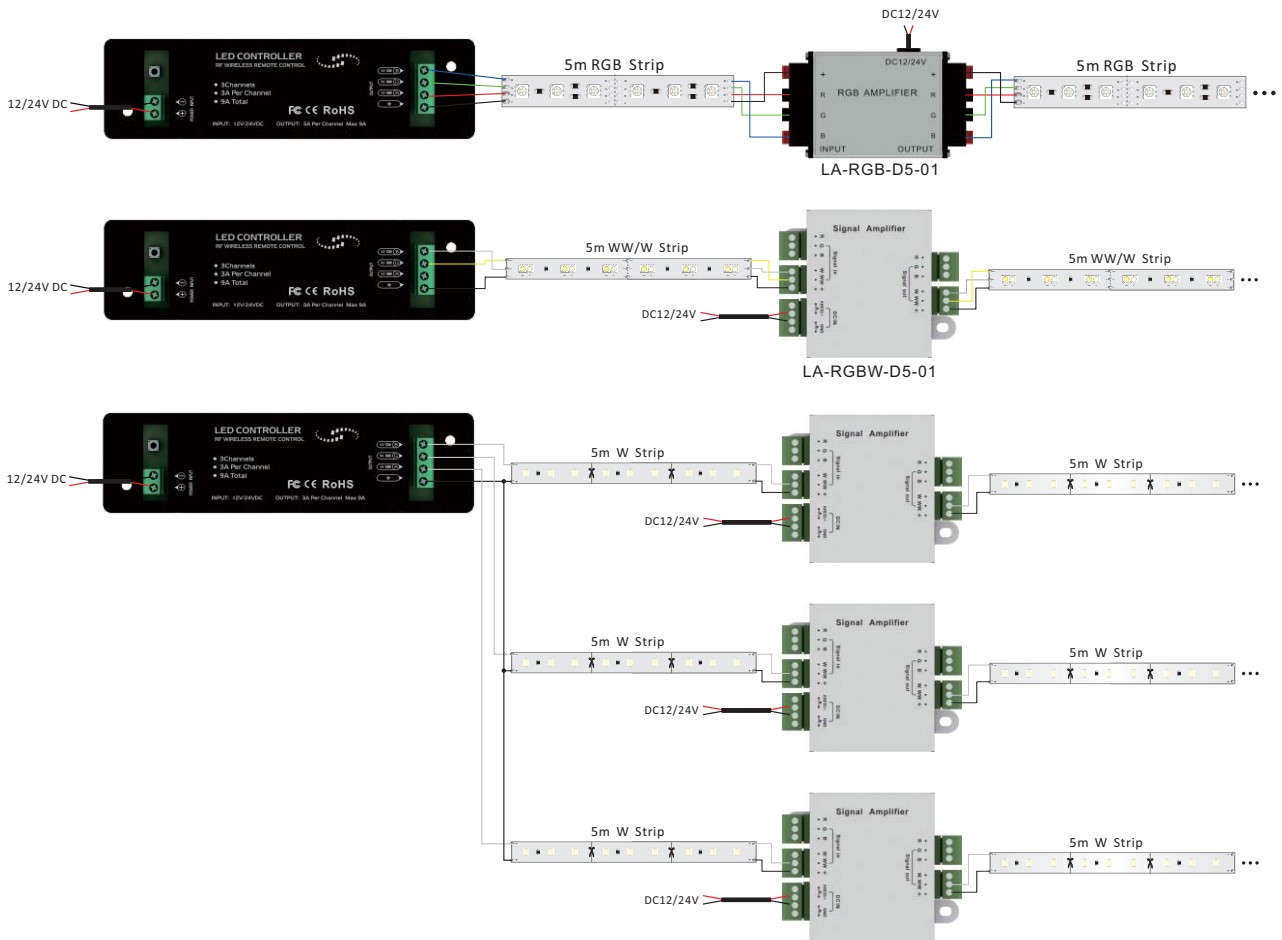
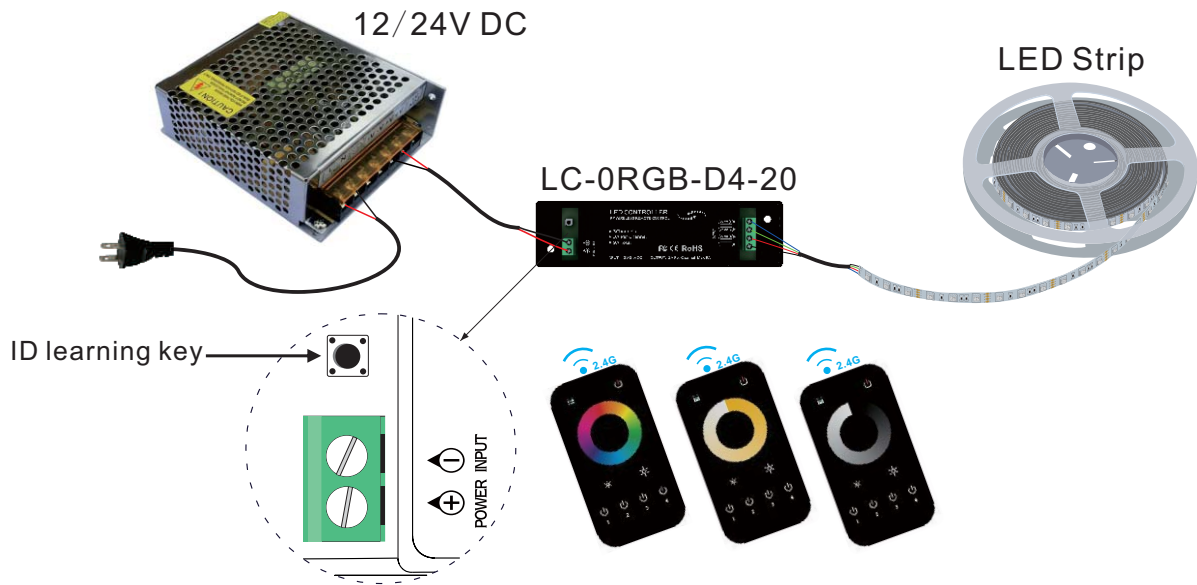

---

## Group display drawing:



### **! Notice:**

- 1.The controller must be installed by professionals;
2. When installing the controller, first power off, then connect LED products with controller, after doing the right, then power on it;
- 3.Good cooling conditions will extend lifetime of controller, please install the product in well-ventilated environment;
- 4.Ensure input voltage conform to voltage range requirement of product;
- 5.Wire size used must be sufficiently load connected and make sure wires are securely connected;
- 6.Before power on, ensure that all the wiring is correct to avoid errors caused by wiring lamps damage;
- 7.If a failure occurs,don't repair without permission,please contact the manufacturer