



PRODUCT SHEET

Capella 150lm 827 45° 1,1W WH 2m cable w/o driver

Art. no: 2173-45-3

Ledpro
by NORLUX

Capella 150lm 827 45° 1,1W WH 2m cable w/o driver

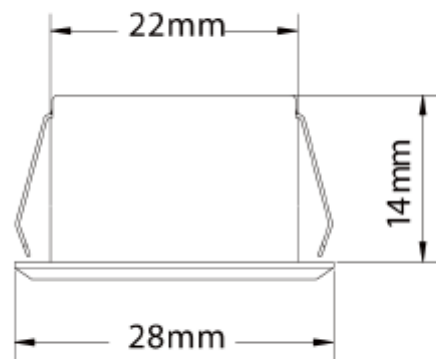

A++

SPECIFICATIONS

Lyskilde :	LED (innebygget)
Systemeffekt [W]:	1,1W
Fargetemperatur [K]:	2700K
Fargegjengivelse [CRI/Ra]:	80
Lumen ut (lm):	130lm
Lumen LED (tc=25):	130lm
Spredningsvinkel [°]:	45°
Optikk:	Klar
Dimmetype:	Avhengig av driver
Tilkobling:	Mini kontakt 2m
Montering:	Innfelt, Gulv, Innredning, Møbel
Utsparring [mm]:	Ø25mm
Forventet Levetid :	L80B50: 50 000h
Lumen/W:	118lm/W
Fargetoleranse [SDCM]:	2
Farge :	Hvit
Lengde [mm]:	22mm
Høyde [mm]:	14mm
Bredde [mm]:	28mm

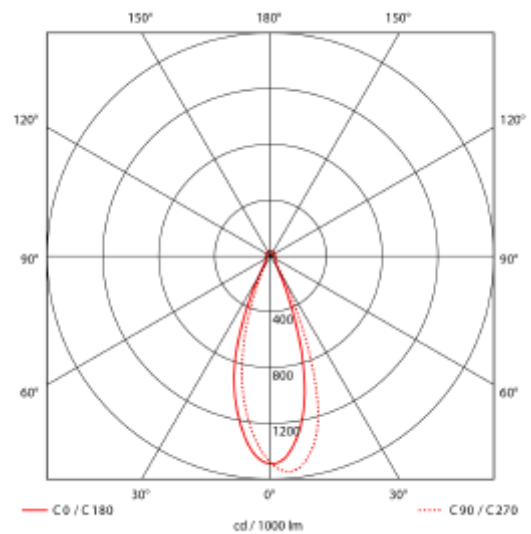



PRODUCT SHEET

Capella 150lm 827 45° 1,1W WH 2m cable w/o driver
Art. no: 2173-45-3



Mini downlight for aksentbelysning i vinduer, hyller og veggisjer eller lignende. 130lm med 45° spredning. Leveres med 2m kabel og minikontakt for rask installasjon. Forgrenere og forlengelseskabel finnes som tilbehør. Kappe for utenpåliggende montering og 350mA driver kjøpes separat. Beregn 2,9-3,3V pr. downlight. Driver må beregnes i forhold til spenning (seriekobling) og effekt. Både fasekutt og DALI-driver kan benyttes som av/på-driver (uten dimming).

On/ Off driver (LED seriekobles)

1-17 stk Q4-350mA-20W-01 Driver 350mA cc (2-58V) 20W IP20 w/3m cable Euro-plug WH

Fasekutt driver (LED seriekobles):

2-3 stk MINID35004NT Driver 350mA cc 4W (6-12V) Phasecut Mini AcTec

5-8 stk D35009NT Driver 350mA 9W (13-26V) Phasecut AcTec

6-15 stk DIM350MA/18W Driver 350mA cc 18W 15-52V

PhaseCut-dim AcTEC

8-12 stk 87500386 Driver 350mA cc(21-42V) LCBI 15W 350mA

Basic Phasecut SR ADV

9-15 stk D35018NT Driver 350mA 18W (26-52V) Phasecut AcTec

DALI driver (LED seriekobles):

2-16 stk LCM-25DA Driver 350/500/600/700/900/1050mA cc 25W DALI/Push MeanWell

1-22 stk 127413 Driver 350-1050mA cc 48V 60W MAXI JOLLY AM/PWM US DALI2 TCI

1-30 stk LCM-40D Driver 350/500/600/700/900/1050mA cc 40W DALI/Push MeanWell.