

# LED-Panel NWC

## INSTALLATION MANUAL



### **⚠ Safety Notes:**

- The product must be installed, maintained, and operated as instructions below.
- Before starting installation of this product, make sure power supply is disconnected.
- Only to be installed by authorized electrician.
- Do not use abrasives or solvents when cleaning.
- Do not install the product if it appears damaged in any way. Check with manufacturer if in doubt.
- Do not modify this fitting in any matter as this will void warranty.
- Check protection class, if class I, it must be earthed.
- Disconnect power supply before maintenance or cleaning.

### **⚠ Sikkerhetsinformasjon:**

- Følg installasjonsmanual for korrekt montering.
- Koble alltid fra strømmen før montering eller vedlikehold.
- Kan kun monteres av autorisert elektriker.
- Monter ikke produktet hvis det er synlig skade. Kontakt forhandler eller produsent.
- Bruk ikke løsemidler ved rengjøring
- Produktet skal ikke under noen omstendigheter endres eller modifiseres.
- Sjekk produktets isolasjonsklasse. Ved isolasjonsklasse I skal produktet jordes.

# ELECTRICAL CONNECTION

Sensor wiring with 12VDC wire dimming ballast or LED driver.

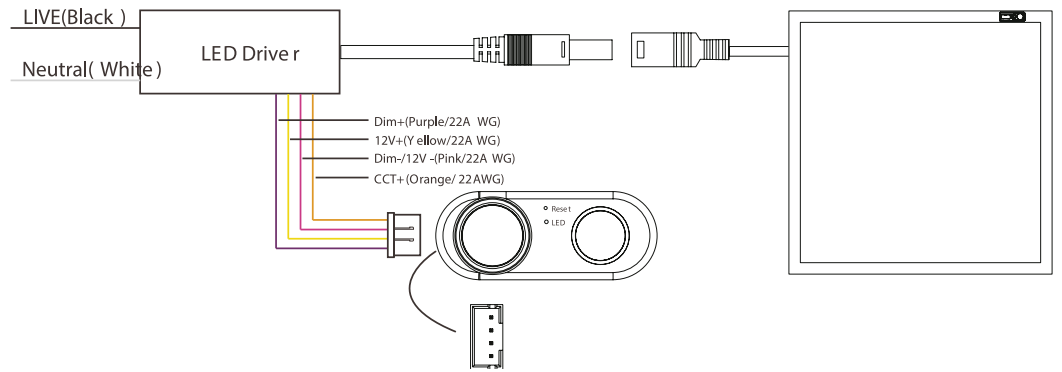

# COVERAGE PATTERNS

Unit of measurements: meters.

- Minor motion
- Major motion

Coverage Side View

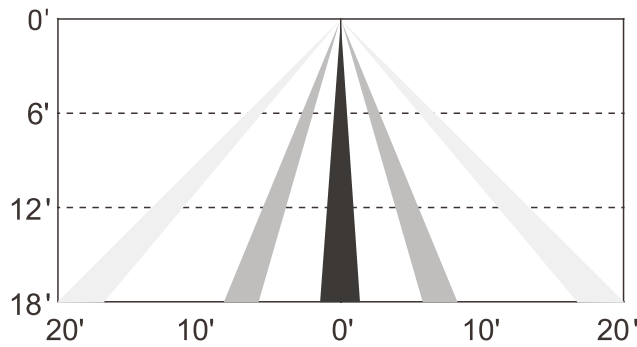

Coverage Top View

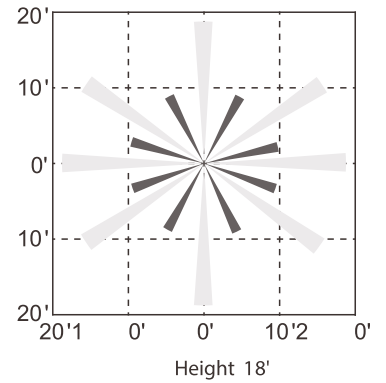

# SENSOR PARAMETER SETTING

**IFS108.A0**

**Low bay sensor**

Input: 12VDC 25mA 0.3W  
Output: 10VDC 10mA 0.1W

Input Type Class 2  
Output Type Class 2  
Output Load Type Specific load- 0-10V interface  
Damp locations

E504054  
LED Controller

ORG	CCT+
PNK	GND
YEL	12V+
PUR	10V+

03-23

RESET  
Reset Button is beside PIR lens

FCC ID: 2A36YLTXY2021

CE

RoHS  
COMPLIANT

The Bluetooth word mark and logos are registered trademarks owned by Bluetooth SIG, Inc. and any use of such marks is under license. Other trademarks and trade names are those of their respective owners.

# APP DOWNLOAD



### Snap-in Ceiling Installation

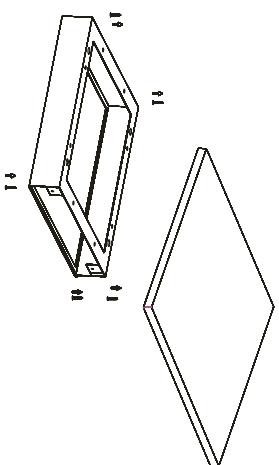

1. Install the bracket in the ceiling.

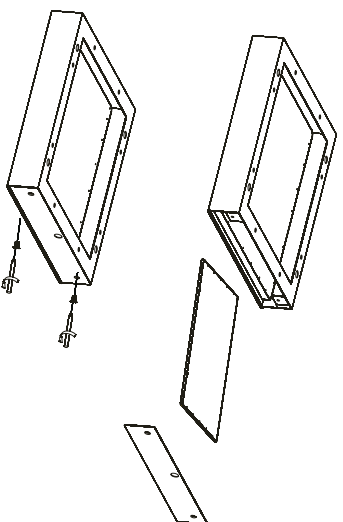

2. Snap the light in the ceiling bracket; then fasten the side panel with screws.

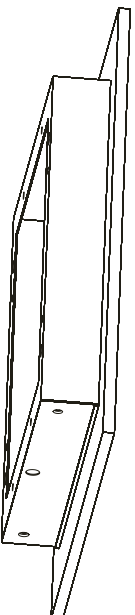

3. Installation finish.

### Schematic diagram for embedded installation

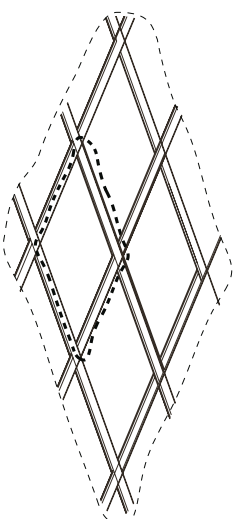

1. Move away ceiling plaster slab, then arrange the wire

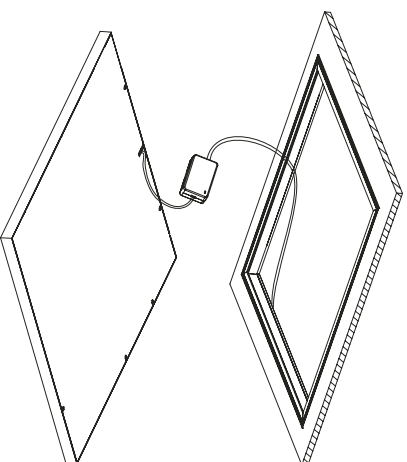

2. Connect the power.

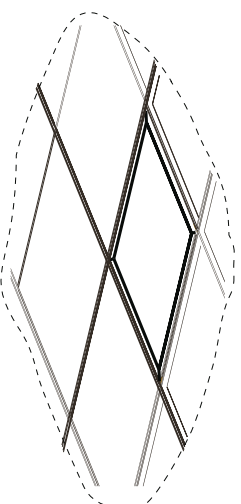

3. Fix the panel light to suitable place.

### Schematic diagram for vertical installation

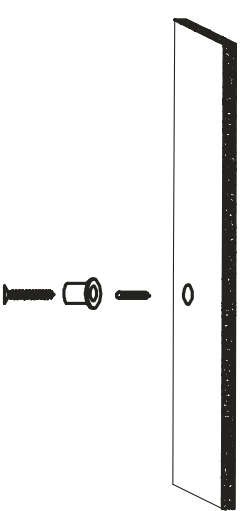

1. Install the hanging fixed block in order.

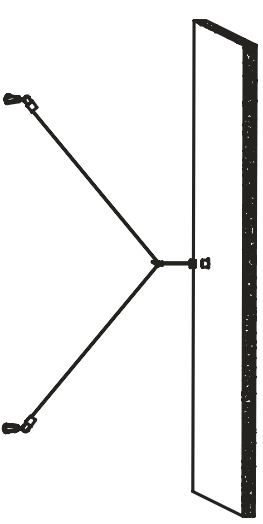

2. Install the Y rope.

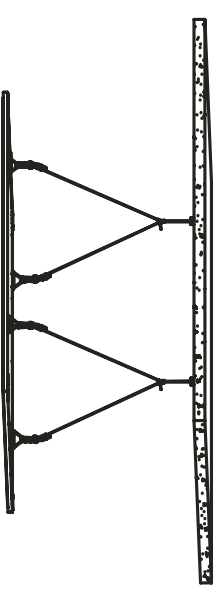

3. Fasten the Y rope end with the easy snap hooks. Use 3 pcs Y rope if 1195mm length.